

Director Viewpoint

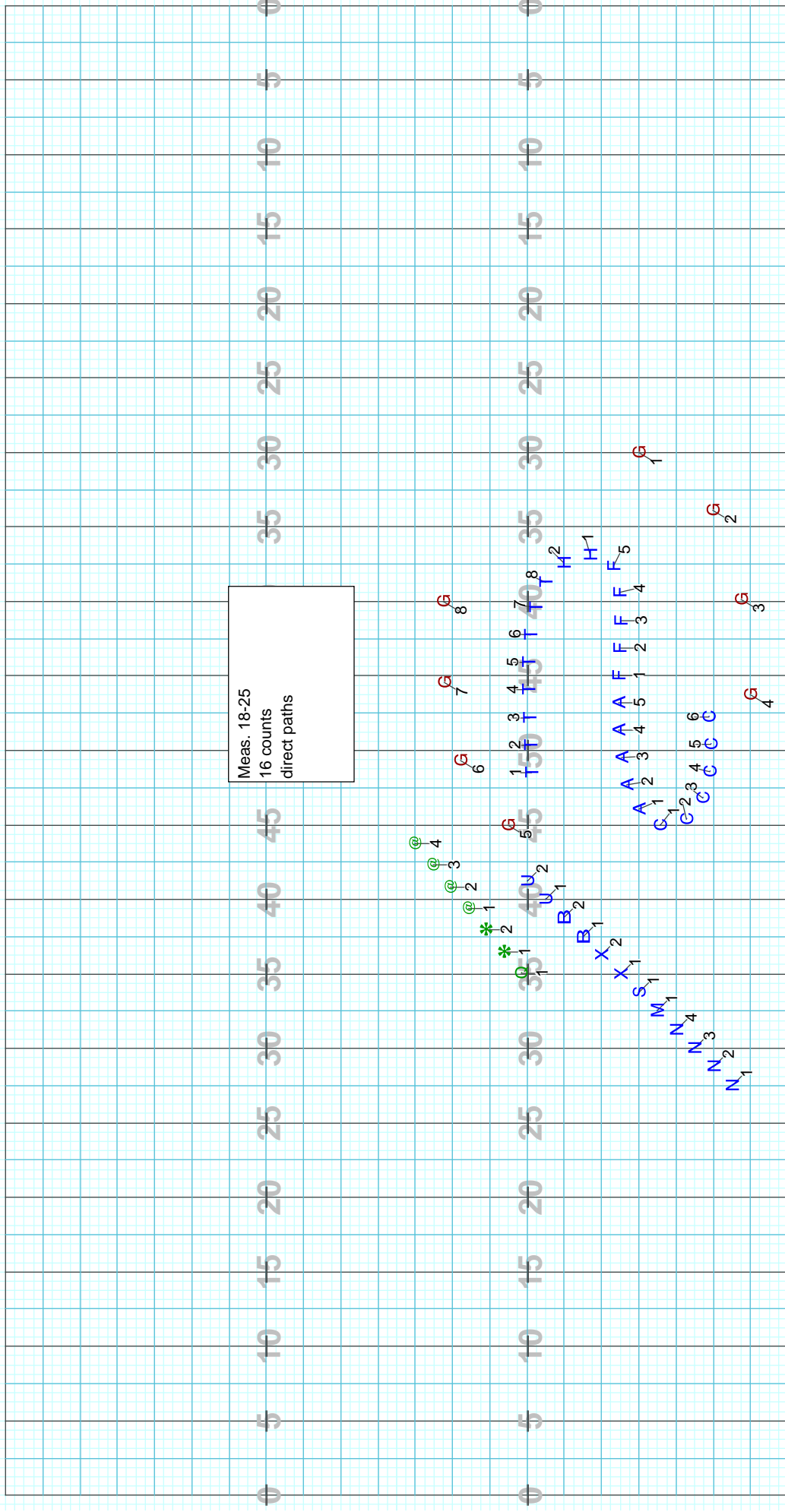

Director Viewpoint

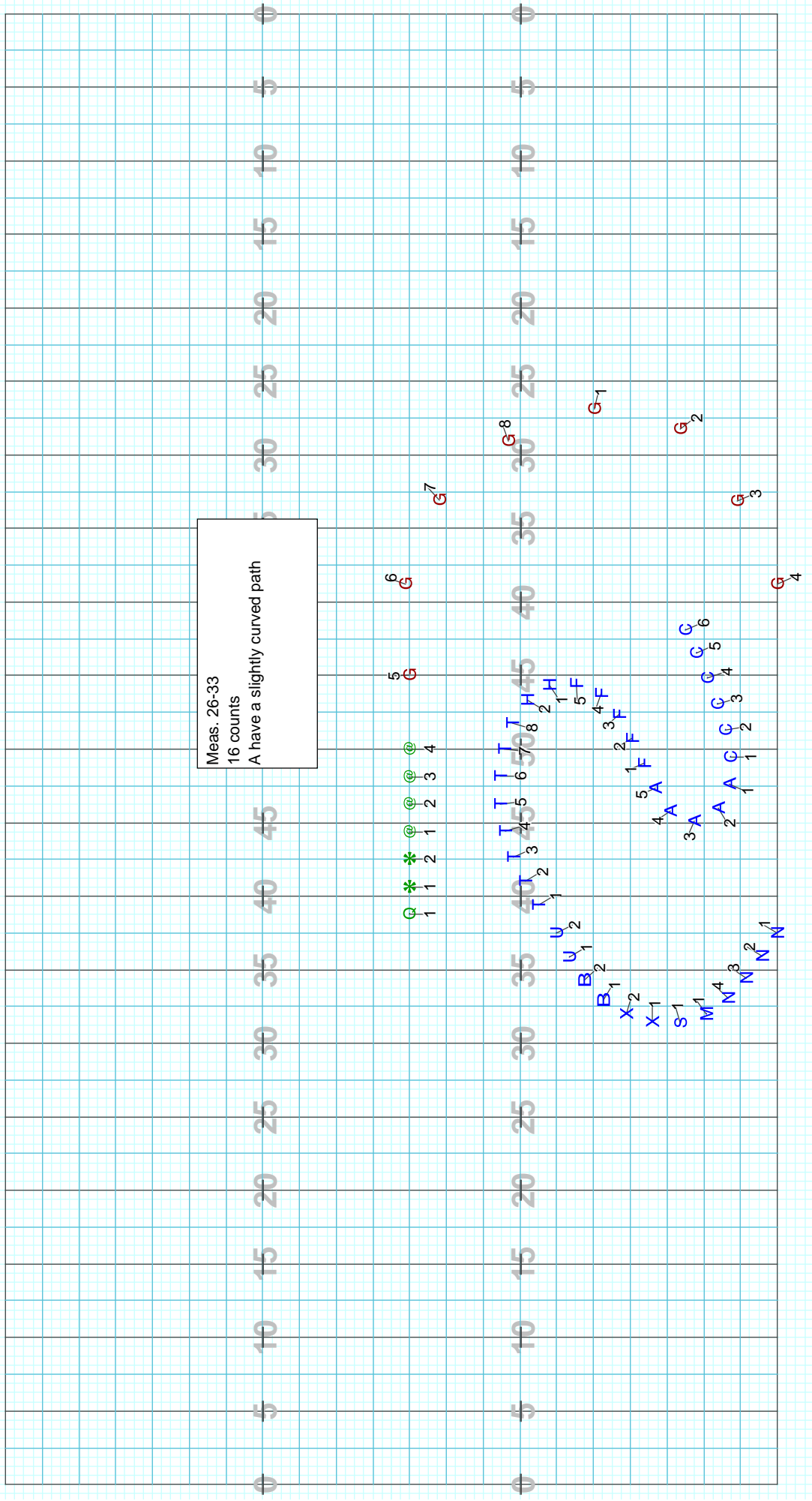

Director Viewpoint

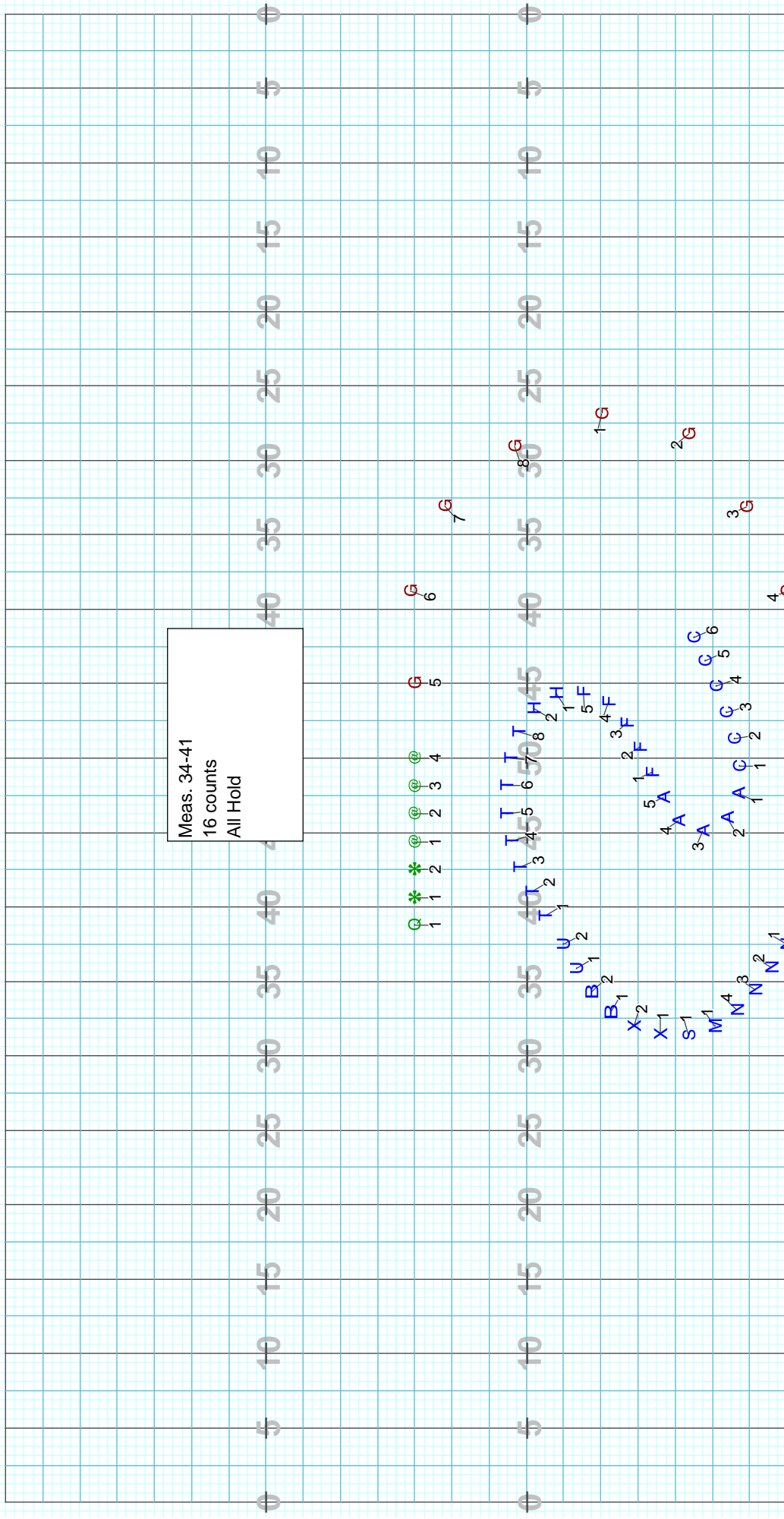

Director Viewpoint

Meas. 42-49
 16 counts
 Band slide and follow or follow the leader

Q 1
 * 1
 * 2
 @ 1
 @ 2
 @ 3
 @ 4

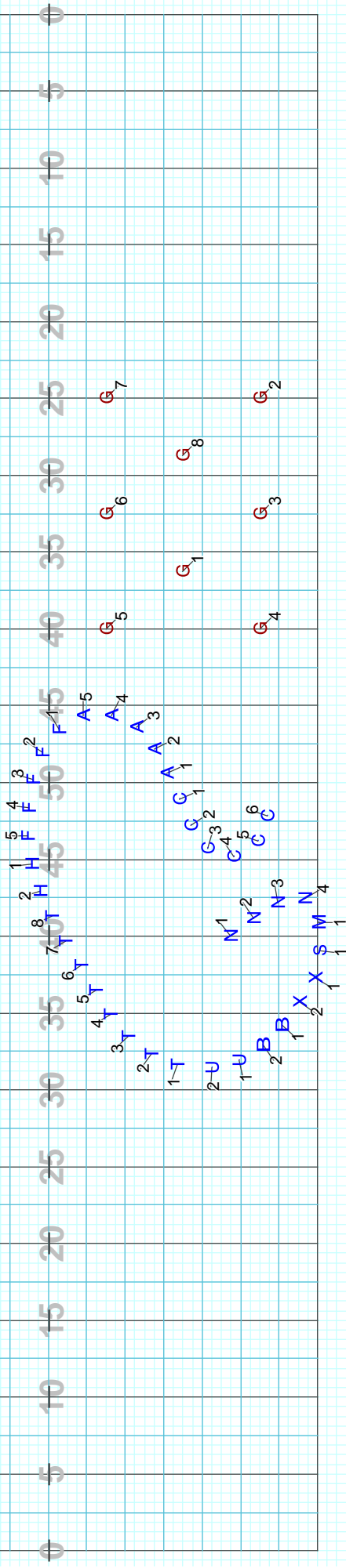

Director Viewpoint

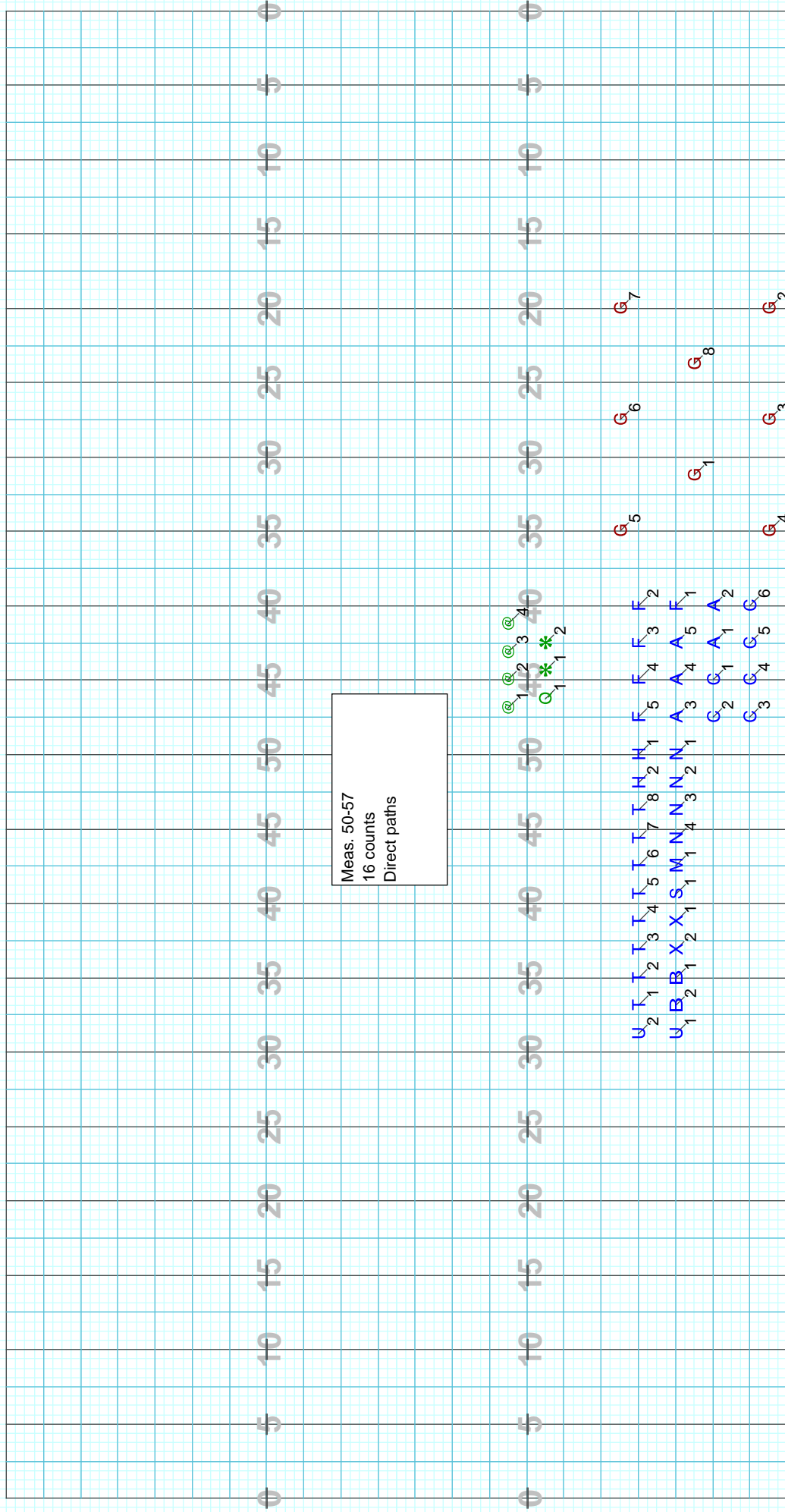

Director Viewpoint

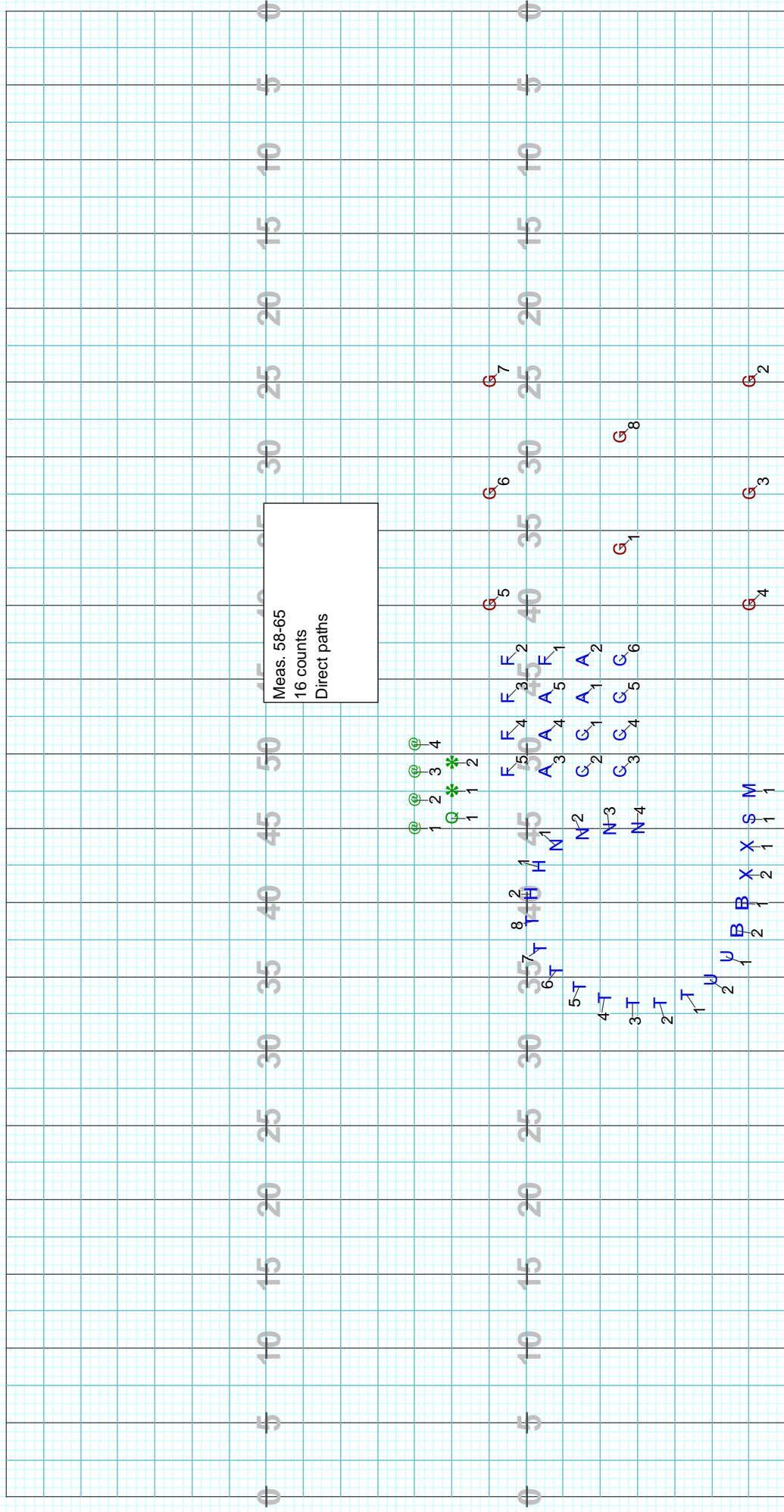

Director Viewpoint

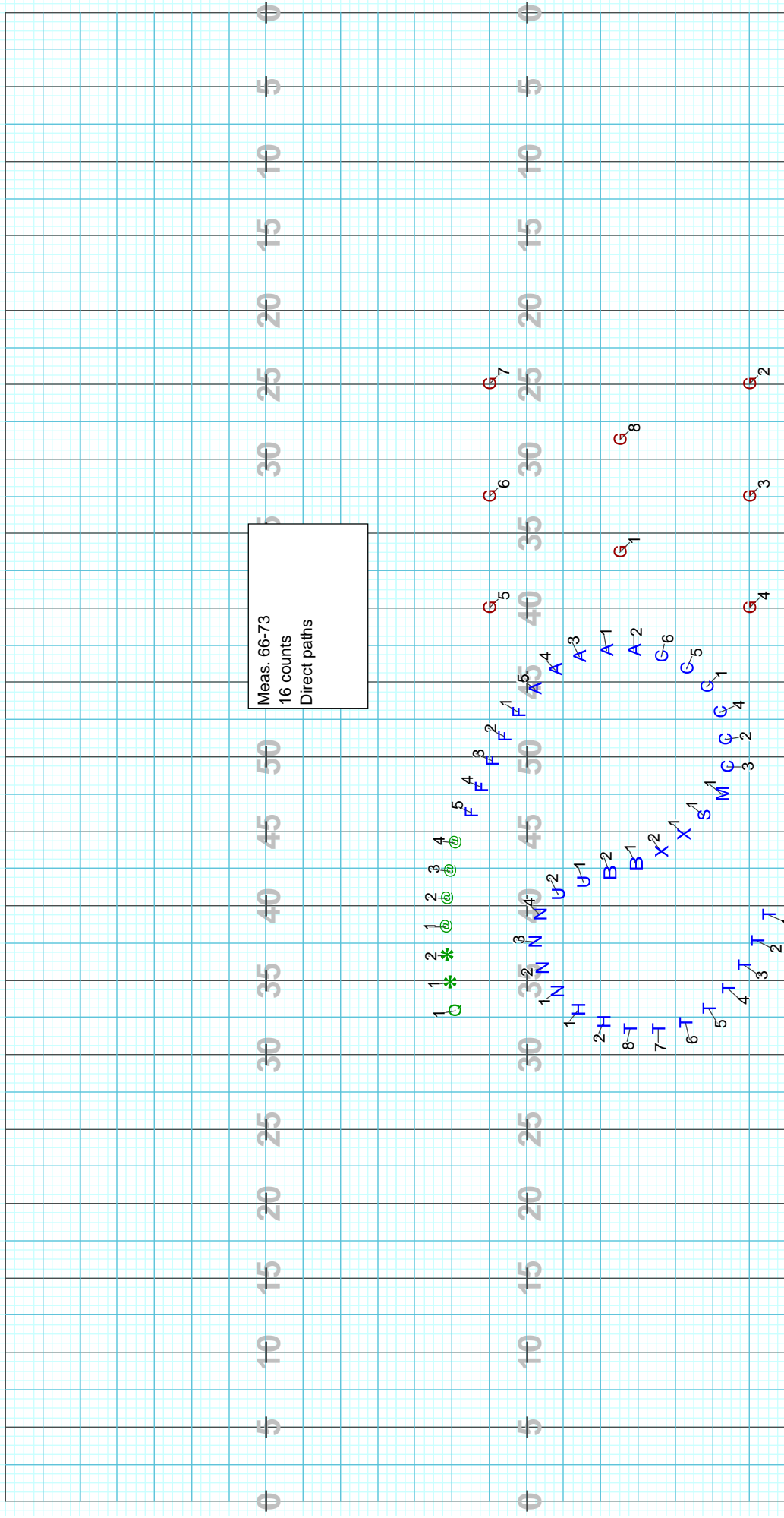

Meas. 66-73
16 counts
Direct paths

Director Viewpoint

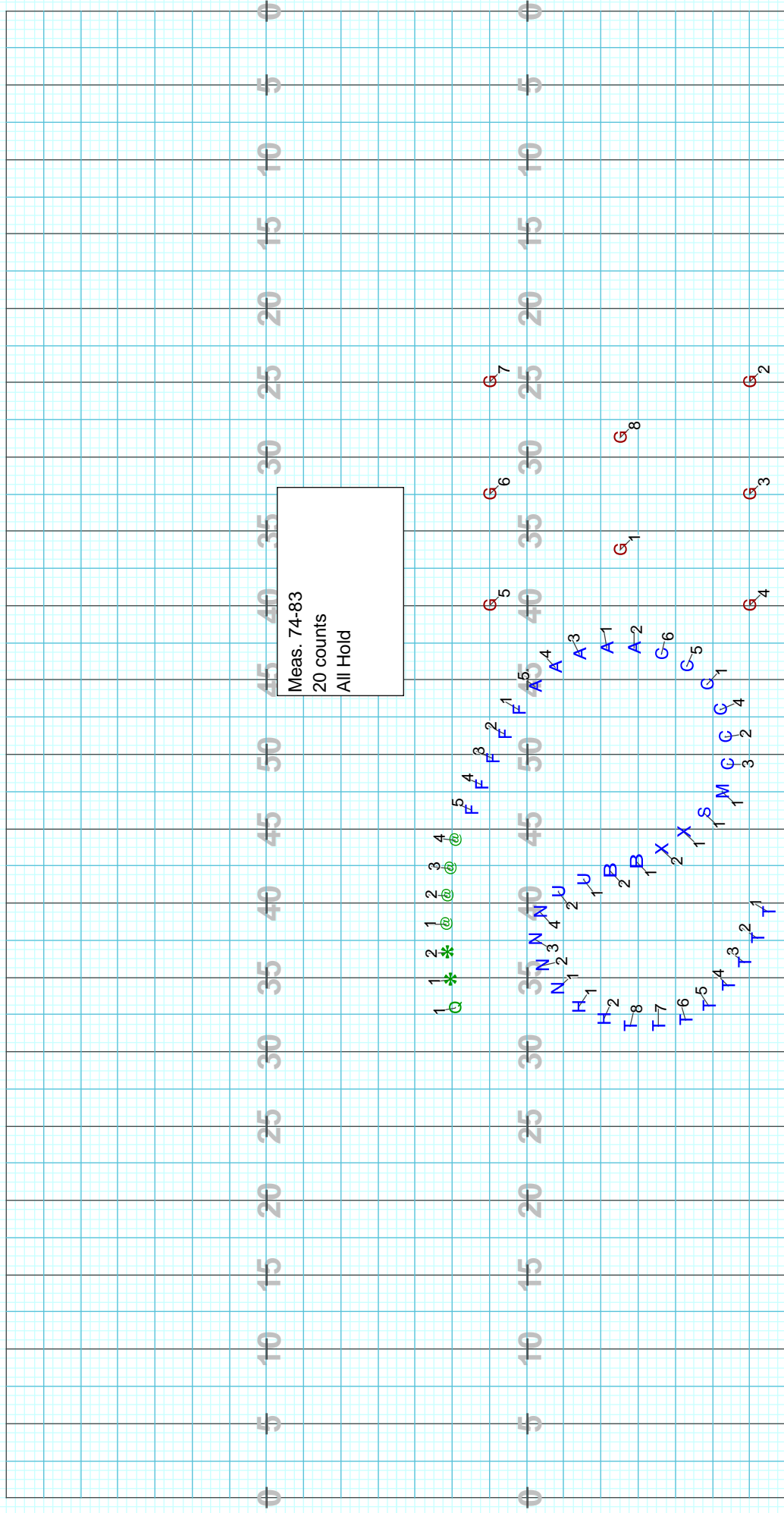

Director Viewpoint

The score is presented on a grid with time markers every 5 units from 0 to 50. It features three instructional text boxes and musical notation for various notes.

Text Box 1 (Meas. 84-91): 16 counts, Direct paths. Located between 45 and 50.

Text Box 2 (Meas. 92-95): 8 counts, Step out of form and face different directions to enhance wild feeling in music. Located between 25 and 30.

Text Box 3 (Meas. 96-99): 8 counts, Take 4 cts. to get back into form then hold End of Song. Located between 10 and 15.

Musical Notation:

- At 30: N₃ N₄ U₂ U₁ F₄ F₂ A₅ A₄ A₁
- At 31: N₂ B₁ X₂ X₁ F₅ F₃ F₁ A₃ A₂ G₆
- At 32: N₁ X₁ S₁ M₁ G₃ G₂ G₄ G₁ G₅
- At 33: H₁ H₂ T₈ T₇ T₆ T₅ T₄ T₃ T₂ T₁
- At 35: G₁ G₂ G₃ G₄ G₅ G₆ G₇ G₈

Director Viewpoint